



User Manual

HPT-15K / HPT-17K / HPT-20K / HPT-25K

Updated Dec 2020

LAW PROVISIONS

The information in these documents is the property of Suzhou Hypontech Co., Ltd. hereafter refer to Hypontech.

No part of this document may be reproduced, stored, or transmitted, in any form or by any means, without the prior written permission of Hypontech.

Internal reproduction used solely for the purpose of product evaluation or other proper use is allowed and does not require prior approval.

Hypontech makes no representations of warranties, express or implied, with respect to this documentation or any of the equipment and/or software it may describe, including (with no limitation) any implied warranties of utility, merchantability, or fitness of any particular purpose. All such representations or warranties are expressly disclaimed. Neither Hypontech nor its distributors or dealers shall be liable for any indirect, incidental, or consequential damages under any circumstances. The exclusion of implied warranties may not apply in all cases under some statutes, and thus the above exclusion may not apply.

Specifications are subject to change without notice. Every attempt has been made to make this document complete, accurate and up-to-date. Readers are cautioned, however, that product improvements and field usage experience may cause Hypontech to make changes to these specifications without advance notice, or per contract provisions in those cases where a supply agreement requires advance notice. Hypontech shall not be responsible for any damages, including indirect, incidental or consequential damages, caused by reliance on the material presented, including, but not limited to, omissions, typographical errors, arithmetical errors or listing errors in the content material.

HYPONTECH WARRANTY

You can download the current warranty conditions from the Internet at www.hypontech.com. To require assistant from Hypontech, please read [CONTACT](#).

Trademarks

All trademarks are recognized, even if not explicitly identified as such. Missing designations do not mean that a product or brand is not a registered trademark.

INFORMATION ON THIS DOCUMENT

Target Group

This document is intended for qualified persons and end users.

Tasks marked with a warning symbol and the caption “[Qualified Persons](#)” require associated skills to avoid and deal with the dangers and risks in installing and using the product and tools described in this document.

Tasks not marked do not require particular qualifications and skillsets, and therefore can be performed by end users.

Qualified Persons

Qualified persons should be familiar and understand all safety regulations and are aware of the potential risks to perform the activities marked in this document.

For qualified persons, the following knowledge and skills are required:

- Knowledge of how an inverter works and is operated
- Knowledge of all applicable standards and directives, including country-specific grid conditions and regulatory guidelines
- Knowledge and training of how to minimize and deal with dangers and risks associated with using, installing, and repairing electrical devices and installations
- Knowledge and training of the installation and commissioning of electrical devices associated with PV systems
- Knowledge and training of and compliance with this document and all safety information
- Knowledge of warranty terms and conditions associated with the product described in this document



NOTICE

Hereby qualified personnel means he/she has the valid license from the local authority in:

- Installing electrical equipment and PV power systems (up to 100V).
- Applying all applicable installation codes.
- Analyzing and reducing the hazards involved in performing electrical work.
- Selecting and using Personal Protective Equipment (PPE).

End Users

End users can be referred to any who intend to use the product described in this document and should avoid performing tasks marked in this document with requirement on qualified persons.

End users should use this document for a comprehensive understanding of the features and functions involved in the product, and as a guideline for performing unmarked tasks by themselves.



WARNING

DO NOT use this product unless it has been successfully installed by qualified personnel in accordance with the instruction of [Section Installation](#) in this document.

Content in the document

This document describes the unpacking, mounting, installation, commissioning, startup, operation, troubleshooting, maintenance, and disconnection of the product as well as the operation of the product user interface (including communication). Applicable inverter models are listed below:

- HPT-15K
- HPT-17K
- HPT-20K
- HPT-25K

This document, as well as any data and illustrations included herein, are reduced to the essential information for the user's guidance, and therefore may deviate from the real product. Update of this document may not be announced but is recorded in the version history.

For the latest version of this document and further information on the described product, please visit HYPONTECH website at www.hypontech.com.

To require assistant from Hypontech, please read [CONTACT](#).

Copyright © 2020 Suzhou Hypontech Co., Ltd. All rights reserved.

Symbols in the document



DANGER

DANGER indicates a hazardous situation which, if not avoided, will result in death or severe injury.



WARNING

WARNING indicates a hazardous situation which, if not avoided, can result in death or severe injury or moderate injury.



CAUTION

CAUTION indicates a hazardous situation which, if not avoided, can result in minor or moderate injury.



NOTICE

NOTICE indicates a situation which, if not avoided, that can result in property damage

SAFETY INSTRUCTIONS



DANGER

Danger due to electrical shock and high voltage

DO NOT touch the operating component of the inverter, it might result in burning or death. **TO** prevent risk of electric shock during installation and maintenance, please make sure that the AC and DC terminals are plugged out. **DO NOT** stay close to the instruments while there is severe weather conditions including storm, lightening etc.



WARNING

The installation, service, recycling and disposal of the inverters must be performed by qualified personnel only in compliance with national and local standards and regulations. Please contact your dealer to get the information of authorized repair facility for any maintenance or repairmen.

Any unauthorized actions including modification of product functionality of any form will affect the validation of warranty service. Hypontech may deny the obligation of warranty service accordingly.



NOTICE

Public utility only

The PV inverter designed to feed AC power directly into the public utility power grid.

DO NOT connect AC output of the device to any private AC equipment.



CAUTION

Risk of damage due to improper modifications. Never modify or manipulate the inverter or other components of the system.

IMPORTANT INSTRUCTIONS

1. All persons who are responsible for mounting, installation, commissioning, maintenance, tests, and service of HYPONTECH inverter products must be suitably trained and qualified for corresponding operations. They **MUST** be experienced and have knowledge of operation safety and professional methods. All installation personnel must have knowledge of all applicable safety information, standards, directives, and regulations.
2. The product must **ONLY** be connected and operated with PV arrays of protection class II, in accordance with IEC 61730, application class A. The PV modules must also be compatible with this product. Power resources other than compatible PV arrays **MUST** not be connected and operate with the product.
3. When designing or constructing a PV system, all components **MUST** remain in their permitted operating ranges, and their installation requirements **MUST** always be fulfilled.
4. Under exposure to sunlight, the PV array may generate dangerous output in DC voltage. Contacts with the DC wires, conductors and live components in the inverter may result in





lethal shocks.

5. High voltages in inverter could cause lethal electrical shocks. Before proceeding any work, including maintenance and/or service, on the inverter, fully disconnect it from all DC input, AC grid and other voltage sources. There **MUST** be a 5-minute waiting time after the full disconnection and discharge of residual energy.
6. The DC input voltage of the PV array **MUST** never exceed the maximum input voltage of the inverter.
7. The PV inverter will generate heat during operation. **DO NOT** touch the heat sink or peripheral surface of the inverter during operation. Temperature of some parts may exceed 60°C.

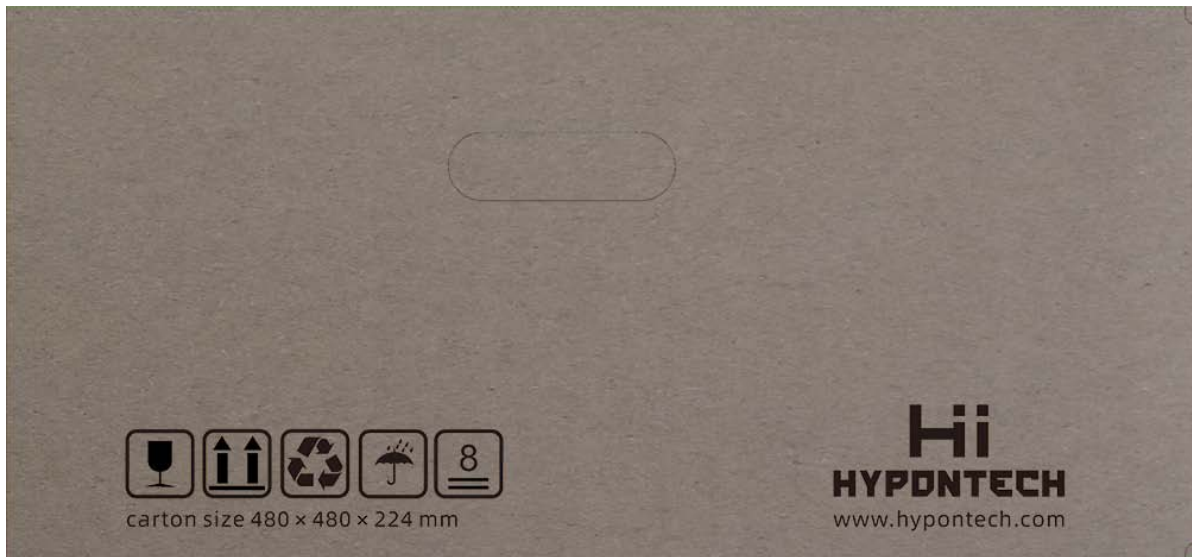
UNPACKING THE PRODUCT









Carton Packaging

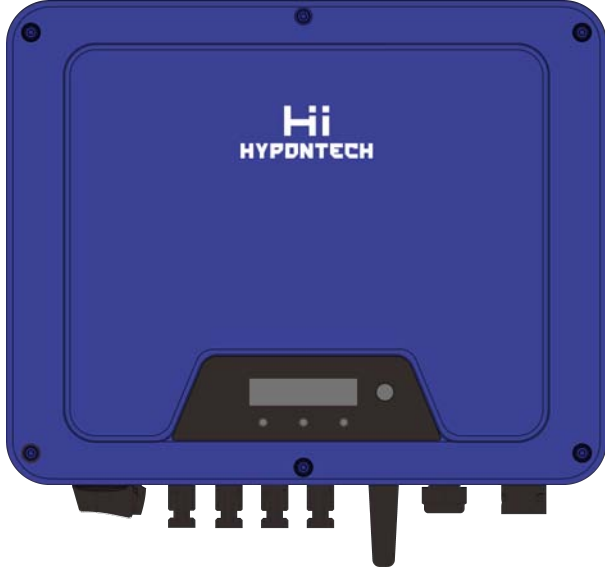

	Breakable Item
	Place Upwards
	Recyclable and Reusable
	Avoid Damp and Moisture
	Shipment Stack Limit: 8

Packing List

After you receive the Hypontech inverter, please check if there is any damage on the carton, and then check the inside completeness for any visible external damage on the inverter or any accessories. Contact your dealer if anything is damaged or missing.

 <p>A blue rectangular HPT inverter with a digital display and several output terminals at the bottom. The logo 'Hi HYPONTECH' is visible on the top panel.</p>	 <p>A black cylindrical connector with a hexagonal base and a small L-shaped metal pin next to it.</p>	
<p>HPT Inverter 1 pcs</p>	<p>Meter/DRED Connector 1 set</p>	
 <p>A black metal mounting bracket with four mounting holes.</p>	 <p>A set of mounting accessories including three long screws, three shorter screws, and three small metal pins.</p>	 <p>Four pairs of black DC plugs, each pair consisting of a male and a female connector.</p>
<p>Mounting Bracket 1 set</p>	<p>Mounting Accessories 1 set</p>	<p>DC Plugs (Sealed) 4 pairs</p>
 <p>A black AC connector with a hexagonal base and a small L-shaped metal pin next to it.</p>	 <p>A small black datalogger device with a QR code on its front panel.</p>	 <p>A grey icon representing a document or file.</p>
<p>AC Connectors 1 set</p>	<p>Datalogger 1 pcs Optional</p>	<p>Documents 1 bag</p>

Overviewing the Product

Product Overview

HPT-15K/17K/20K/25K is a 3-phase grid-tied solar inverter with dimensions of 425 (Width) × 351 (Height) × 200 (Depth) in mm.

The product is equipped with 4 sets (male + female) of PV input terminals, 2 communication ports, a LED&LCD (or LED only, by customer option) as user interface for status display and on-site configurations.

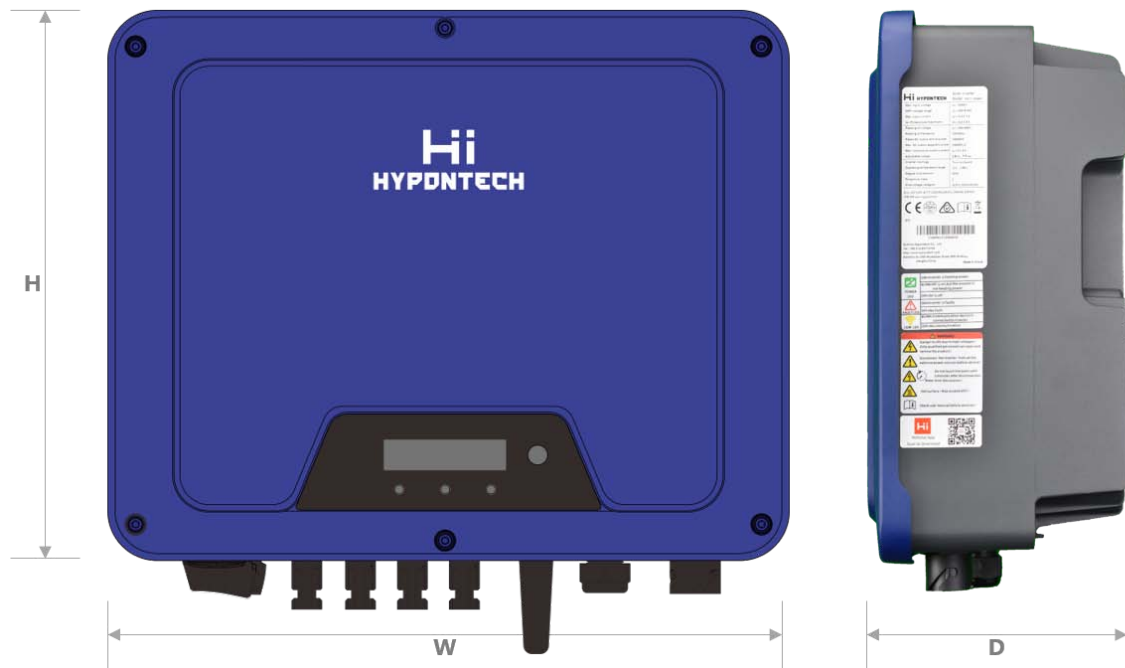

Width W	425 mm
Height H	351 mm
Depth D	200 mm



A	LCD Display
B	LED Indicator
C	Button

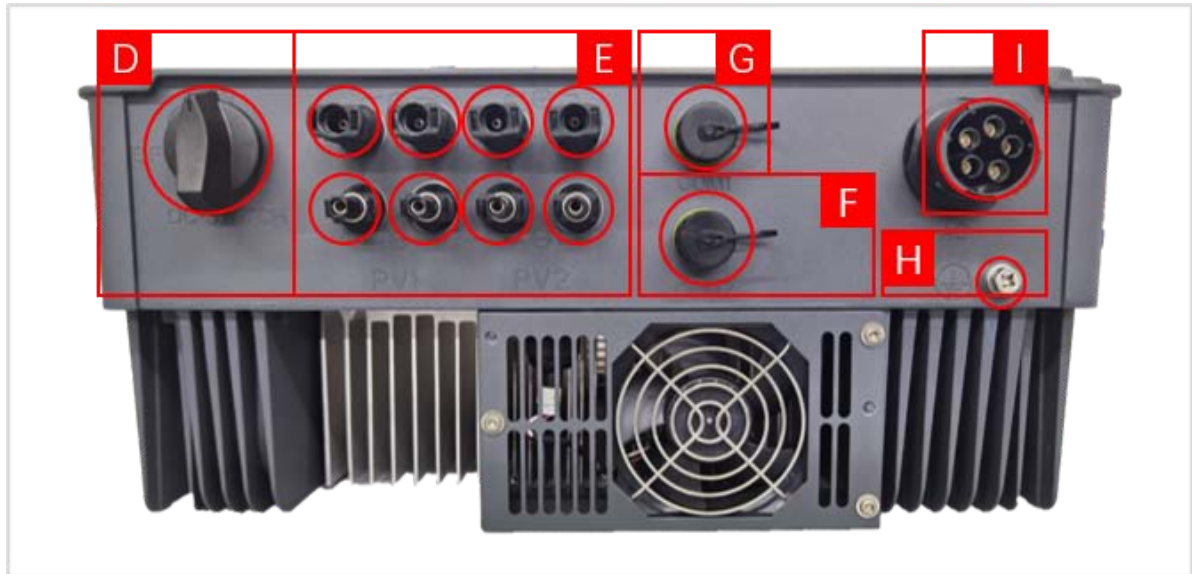





D	DC Switch
E	PV Terminals
F	COM2: Meter/DRED
G	COM1: Wi-Fi / GPRS / RS485
H	Secondary PE Terminal
I	AC Terminal

Symbols on the Product

You can identify the inverter by the side nameplate. Information such as serial number (SN), type of the inverter, as well as inverter specifications are specified on the side name plate. The name plate is on the middle part of the right side of the inverter housing. And the following figure is the side name plate example as on HPS-5000D.



				
CE Mark	TUV Mark	RCM (Regulatory Compliance Mark)	Documents Included	DO NOT DISPOSE with household waste

You can identify the inverter by the side nameplate. Information such as serial number (SN), type of the inverter, as well as inverter specifications are specified on the side name plate. The name plate is on the middle part of the right side of the inverter housing. And the following figure is the side name plate example as on HPS-5000D.

INSTALLING THE PRODUCT

Safety



DANGER

DANGER to life due to potential fire or electricity shock.

DO NOT install the inverter near any inflammable or explosive items. This inverter will be directly connected with **HIGH VOLTAGE** power generation device. The installation must be performed by qualified personnel only in compliance with national and local standards and regulations.



NOTICE

NOTICE due to the inappropriate or the harmonized installation environment may jeopardize the life span of the inverter.

Do not expose to direct sunlight to avoid power derating due to increase in the internal temperature of the inverter.

Do not expose to rain and snow cover to enhance inverter life span.

The installation site **MUST** have sufficient ventilation condition.



Mounting Instructions

1. **DO NOT** mount the inverter near any inflammable materials.
2. **DO NOT** mount the inverter near any explosive materials.
3. For easy installation and operation, it is ideal to mount the inverter on a height that the display could match eye level.
4. The bottom side where all commissioning terminals are equipped **MUST** always point downwards.
5. Inverter(s) need to be installed in places that can avoid inadvertent contact, especially from children.
6. Installation methods, location and mounting surface must be fitting for the inverter's weight and dimensions.
7. The inverter(s) should be installed in an accessible location for convenience of future operation, maintenance, and service.

8. The inverter performance peaks at ambient (room) temperature lower than 45°C.
9. When installing home/residential systems, it is recommended to install and mount the inverter on a solid, concrete-made wall. Avoid mounting the inverter on composite/plaster boards or any walls made with materials of alike, as it would induce unnecessary noise during operation and potential risk of falling.
10. **DO NOT** cover the inverter **NOR** place any objects on top of the inverter.

Installation Requirements

For optimal heat dissipation of the inverter and sufficient space for maintenance, please ensure the clearances are sufficient between the product(s) and other surroundings as indicated below:

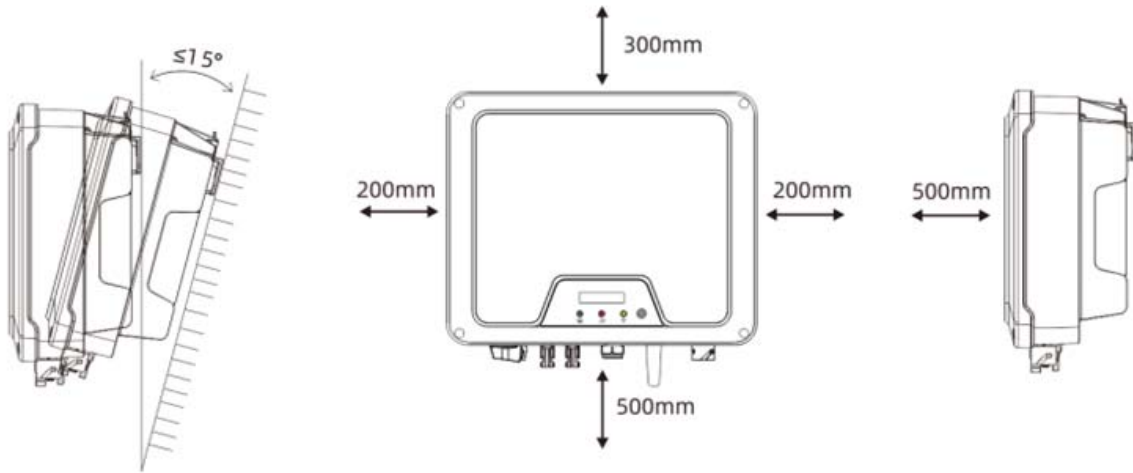



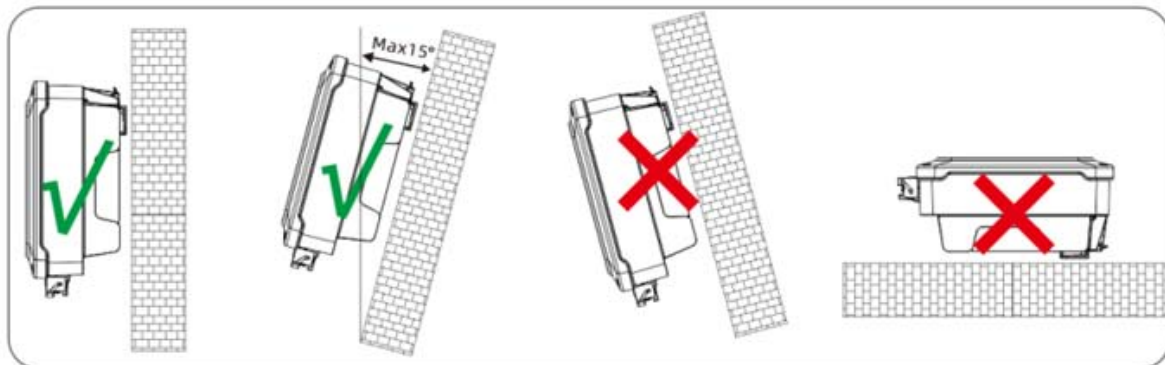

WARNING

- **DO NOT** mount the inverter on tilting surface over 15° backwards. Please mount the inverter on a vertical wall surface.
- **DO NOT** mount the inverter on any surfaces tilting forward or to either sides.
- **DO NOT** mount the inverter on a horizontal surface.

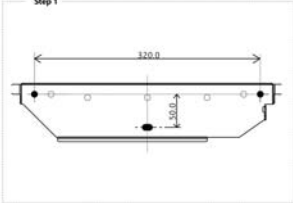
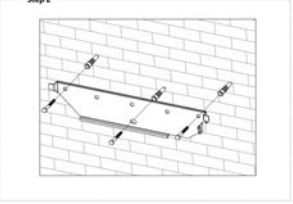

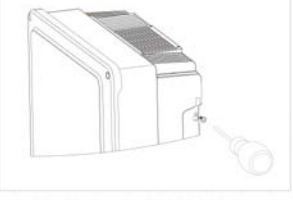
Mounting Procedure

	<p>1. Use mounting bracket as a template for position markings of drilling holes. Align them horizontally.</p>
	<p>2. Drill the holes of 10mm diameter and 70mm depth.</p>
	<p>3. With the provided pack of mounting accessories, insert the expansion bolts (anchors) into drilled holes. Fix the mounting bracket on the wall surface with screws and tighten using a ratchet or box wrench.</p>
	<p>4. Hold up the inverter with a slightly tilt forward. Hang up the inverter and attach it to the mounting bracket. Check both sides of the heat sink to ensure the inverter is stably attached to the bracket.</p>
	<p>5. Use M5 screws (T25 screwdriver, torque 2.5 Nm) to attach the heat sink fins to the mounting bracket. It is recommended to attach the anti-theft lock to the inverter. Lock diameter ϕ 4- 5.5mm recommended.</p>



NOTICE

The lock is not included in the package.

CONNECTING THE PRODUCT

Safety



DANGER

Danger due to electrical shock and high voltage

DO NOT touch the operating component of the inverter, it might result in burning or death. **TO** prevent risk of electric shock during installation and maintenance, please make sure that the AC and DC terminals are plugged out. **DO NOT** stay close to the instruments while there is severe weather conditions including storm, lightening etc.



NOTICE

Qualified Personnel ONLY

AC Connection

Integrated RCD and RCM

The inverter is equipped with integrated RCD (Residual Current Protective Device) and RCM (Residual Current Operated Monitor). The current sensor will detect the volume of the current leakage and compare it with the pre-set value, if the current leakage exceeds the permitted range, the RCD will disconnect the inverter from the AC load.

AC Connector



NOTICE

AC Output Cable selection:

Outdoor copper cable | Diameter: 18-25 mm

Cross-section:

15K: 6-12 mm²

17K: 6-16 mm²

20K: 10-16 mm²

25K: 10-25 mm²

Step 1

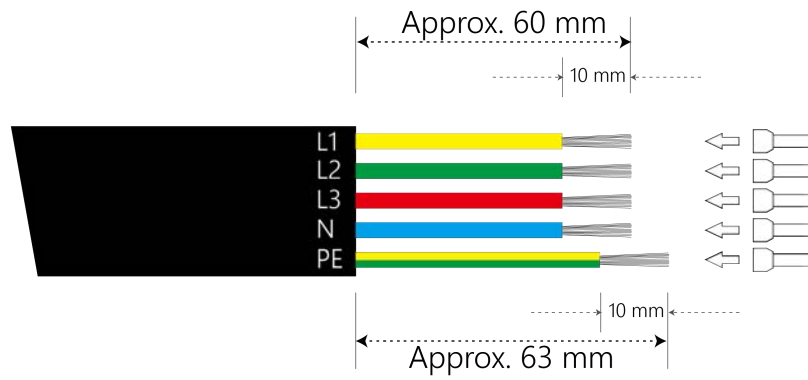

Strip the cable
Dress the conductor with ferrules
acc. to DIN 46228-4 and crimp.

Step 2

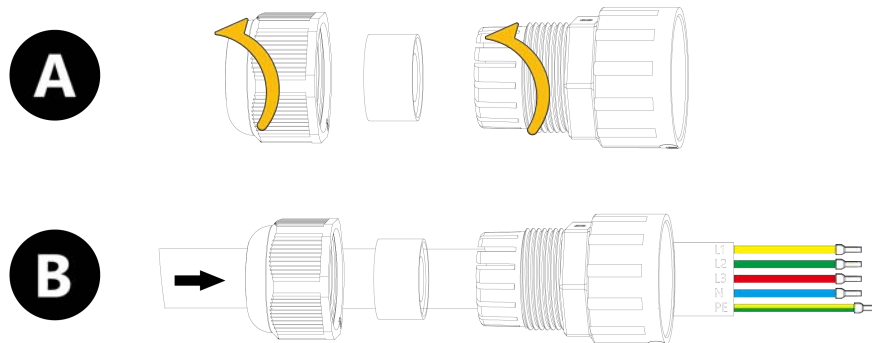

- A.** Unscrew the swivel nut from the threaded sleeve.
- B.** Thread the swivel nut and threaded sleeve over the AC cable.

Step 3

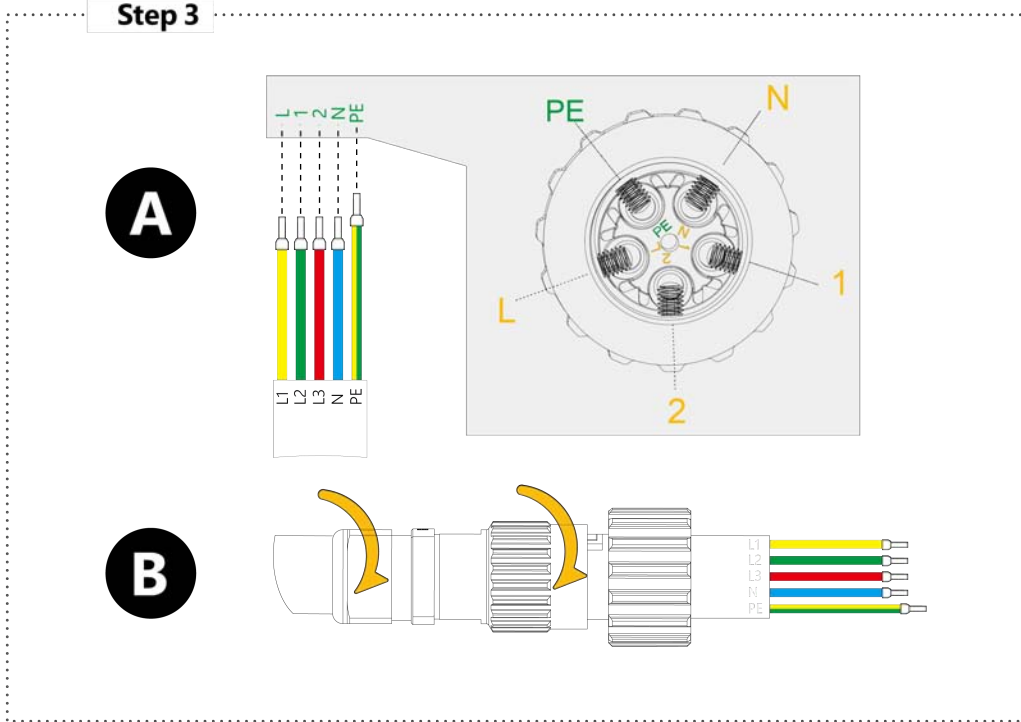

- A. Insert corresponding terminals.
- B. Tighten the screws (torque 0.6 ± 0.1 Nm).

Step 4

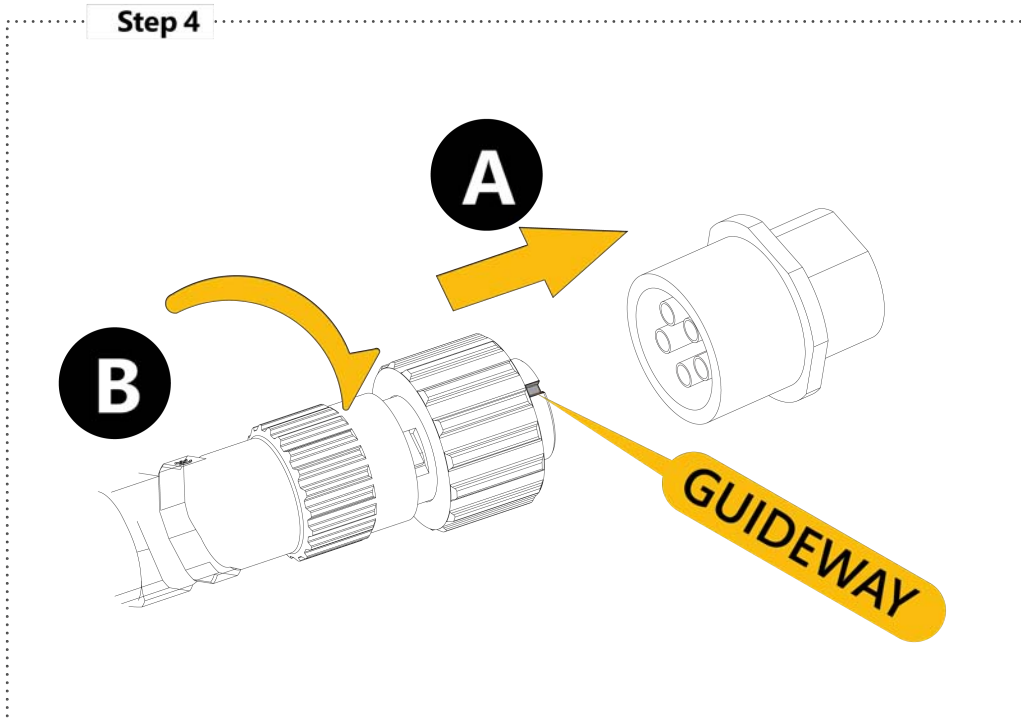

- A. Push the AC Connector into the AC socket underneath the product.
- B. Tighten firmly.



NOTICE

Ensure that the connector has been correctly installed!

AC Isolator Types

Please install an individual 2-stage miniature circuit breaker according to the following specifications.

Model	Maximum Output Current (A)	AC Breaker Rated current (A)
HPT-15K	24	32
HPT-17K	27.6	32
HPT-20K	31.9	40
HPT-25K	36.3	50

DC Connection

- PV modules of the connected strings **MUST** be of: the same time, identical alignment and tilting angle.
- Before commissioning and connecting the PV arrays, the DC switch **MUST** be on **OFF** position.
- Parallel strings **MUST** have the same number of modules.
- It is **mandatory** to use the DC connectors within package for the connection of PV arrays.
- The polarity of the PV arrays **MUST** be compatible to the DC connectors of the inverter.
- The DC input voltage AND DC input current of the PV array **MUST** never exceed the maximum input allowance of the inverter.



NOTICE

Recheck product parameter for correspondent Max. Input Voltage and Max. Input Current in section [PRODUCT PARAMETERS](#)



NOTICE

DC Cable Selection:

Standard outdoor PV cable | PV1-F Model recommended | Conductor cross-section: 2.5-6mm² | Cable outer diameter: 5-8 mm

Step 1

Strip the cable insulation

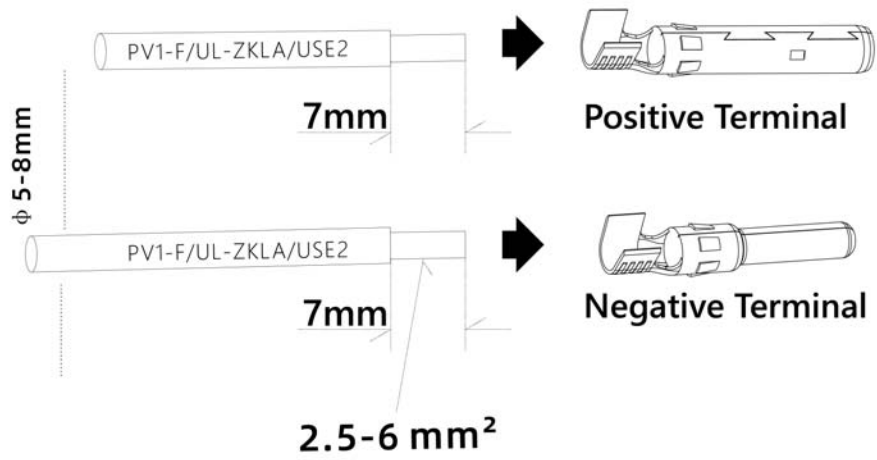

Step 2

Assemble the cable ends

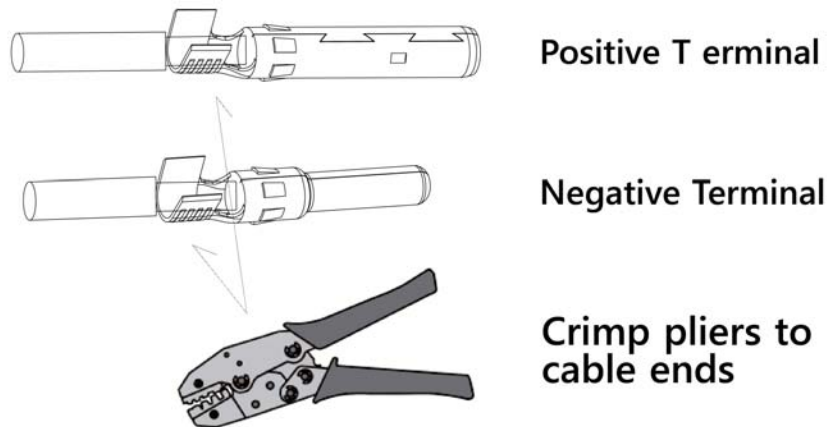

Step 3

Assemble the connectors

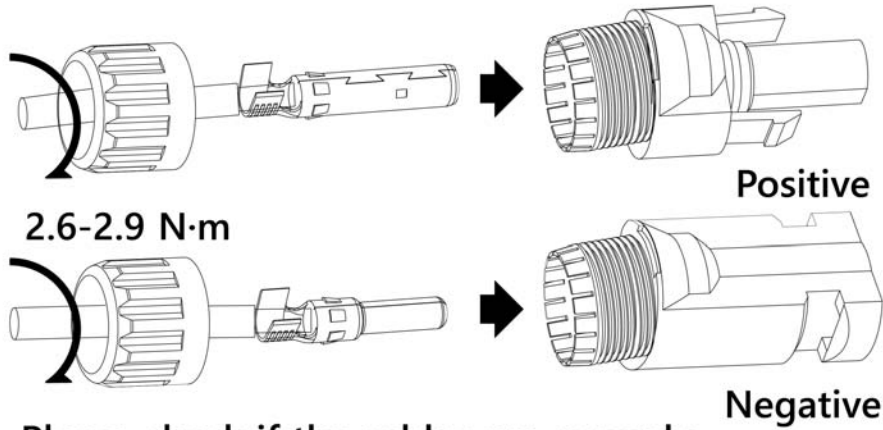

Please check if the cables are securely installed by pulling outwards

Step 4

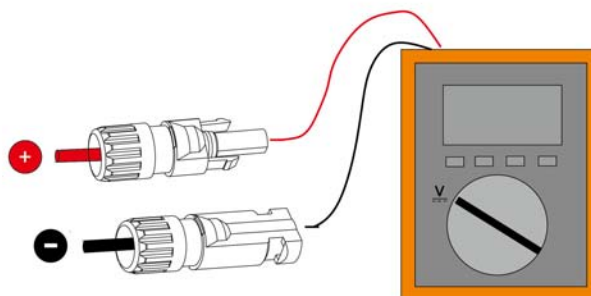

**Check the polarities of the PV strings
Check the open-circuit voltage is less than inverter Max. Input Voltage**

Step 5

Remove the waterproof caps from PV terminals

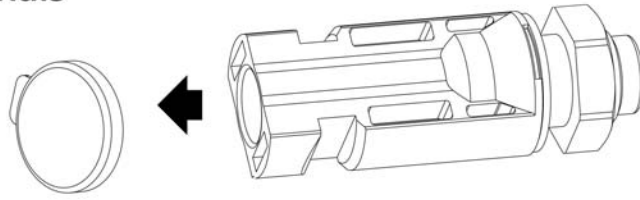

If there is an unused terminal, please seal it with the cap

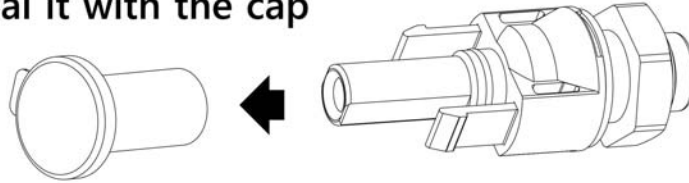

Step 6

Insert the connectors into the terminal till you hear an audible click.

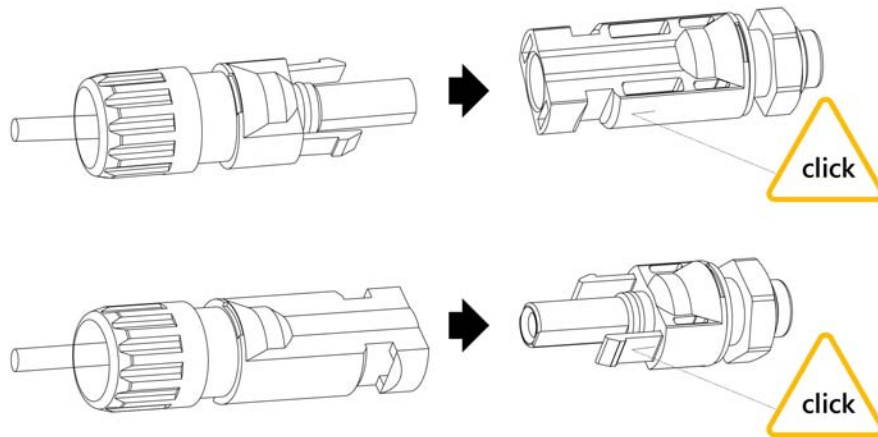

Additional PE / Grounding Connections

A secondary PE terminal is equipped at the bottom of the Inverter to provide double insurance of reliable grounding. Please follow the steps as below:



NOTICE

PE Cable Selection:

Procedure:

1. Insert the grounding conductor into the suitable terminal lug and crimp the contact.
2. Align the terminal lug with the grounding conductor and the ground washer on the screw.
3. Tighten it firmly into the housing.

! NOTICE

Screwdriver type: T25, torque: 3.5-5Nm

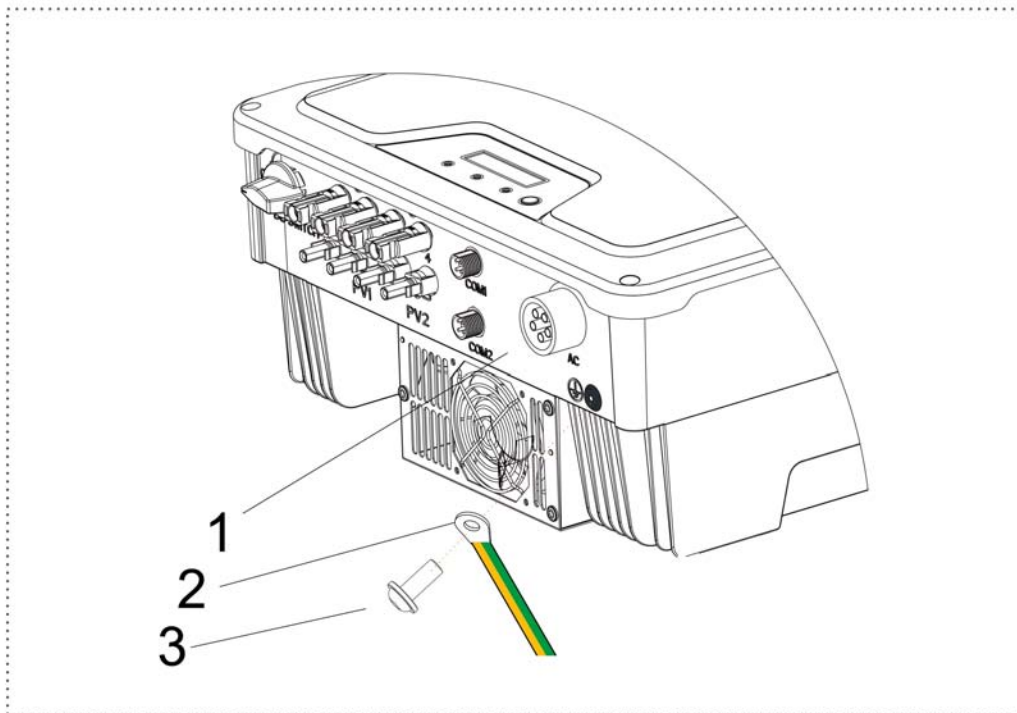

Object	Description
1	Housing
2	M6 terminal lug with protective conductor
3	M6 x 16 screw

! NOTICE

Proper grounding connection of the second PE terminal and the AC terminal is mandatory.

NOT properly connecting both PE will void all product warranty.

SETTING UP COMMUNICATION



NOTICE

Qualified Personnel ONLY

Datalogger Installation

To install **WIFI/GPRS/Ethernet** Stick, follow the procedure below:

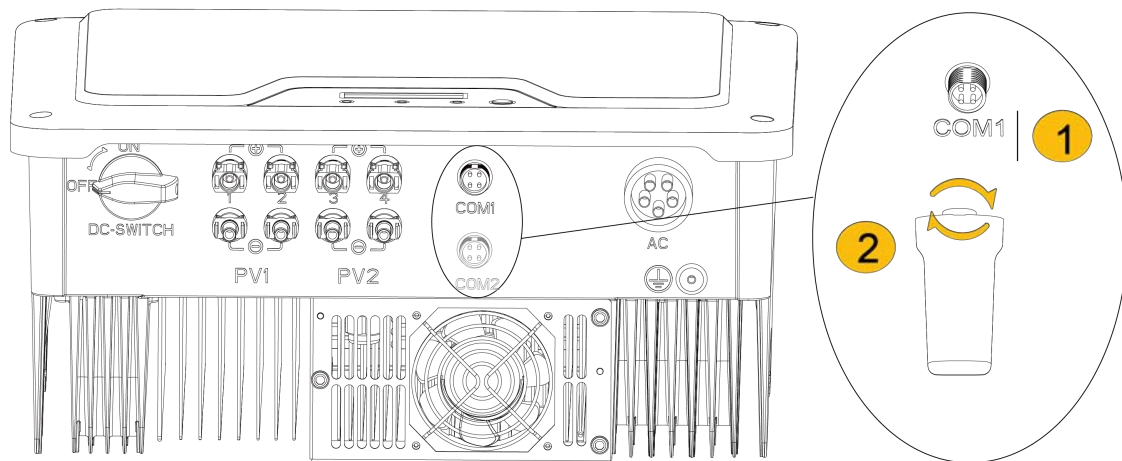

1. Unpack the Datalogger from package.
2. Unscrew the cap in COM1 port and plug the Datalogger in and tighten.

For user guidance and configuration of Wi-Fi Stick / Wireless Datalogger, please refer to the corresponding HYPONTECH Wi-Fi Stick Guide manual.

Printed version of HYPONTECH Wi-Fi Stick Guide is included inside Documents pack, or an online manual on HYPONTECH website at [Download Section](#).

RS485 / Smart Meter / DRED Installation

Position

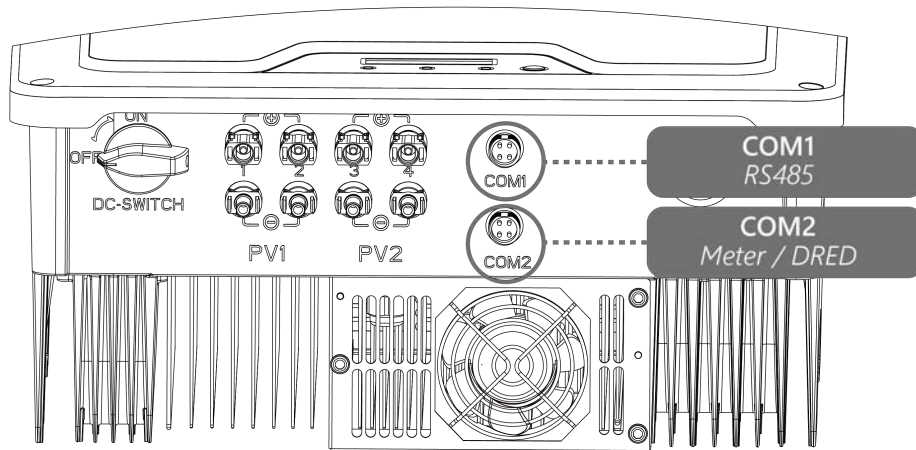

Step 1

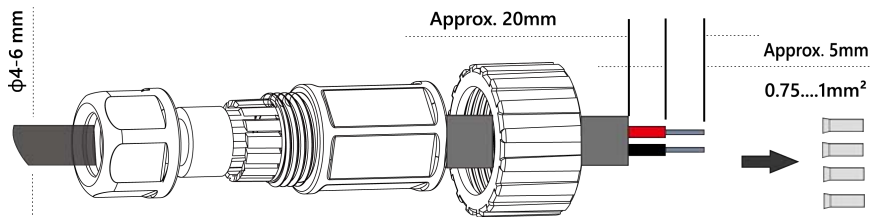

Insert the wires into suitable ferrules (DIN 46228) and crimp.

Step 2

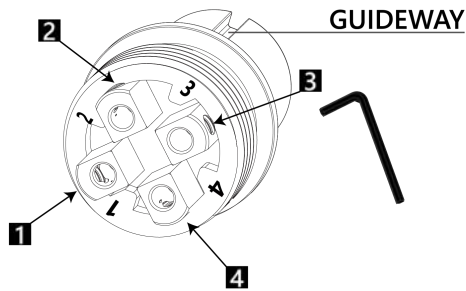

Insert the crimped conductors accordingly into their corresponding terminals and tighten the screws use the screwdriver in the attached bag.

▶ RS485 FOR COM1

Power + ▶ PIN 1
Power - ▶ PIN2
RS485 A ▶ PIN3
RS485 B ▶ PIN4

▶ METER/DRED FOR COM2

RS485 B ▶ PIN1
RS485 A ▶ PIN2
COM LOAD/0 ▶ PIN3
REF GEN/0 ▶ PIN4

Step 3

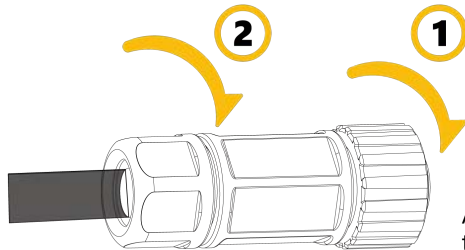

Assemble the locking cap threaded sleeve and swivel nut together.

Step 4



Screw the connector into the socket and tighten firmly.



WARNING

When installing RS485, the COM sealing plate needs to be removed. All operation MUST NOT proceed until AC and DC power is securely disconnected and discharged to prevent electric shocks.

Smart Meter Installation

A smart meter can be installed externally to provide a solution of Zero-injection (also known as: anti-reflux, zero feed-in) function. It is a function that the inverter automatically adjusts the Output Power to match the real-time consumption power of loads in the system. Therefore, the system will not feed any energy to the grid.

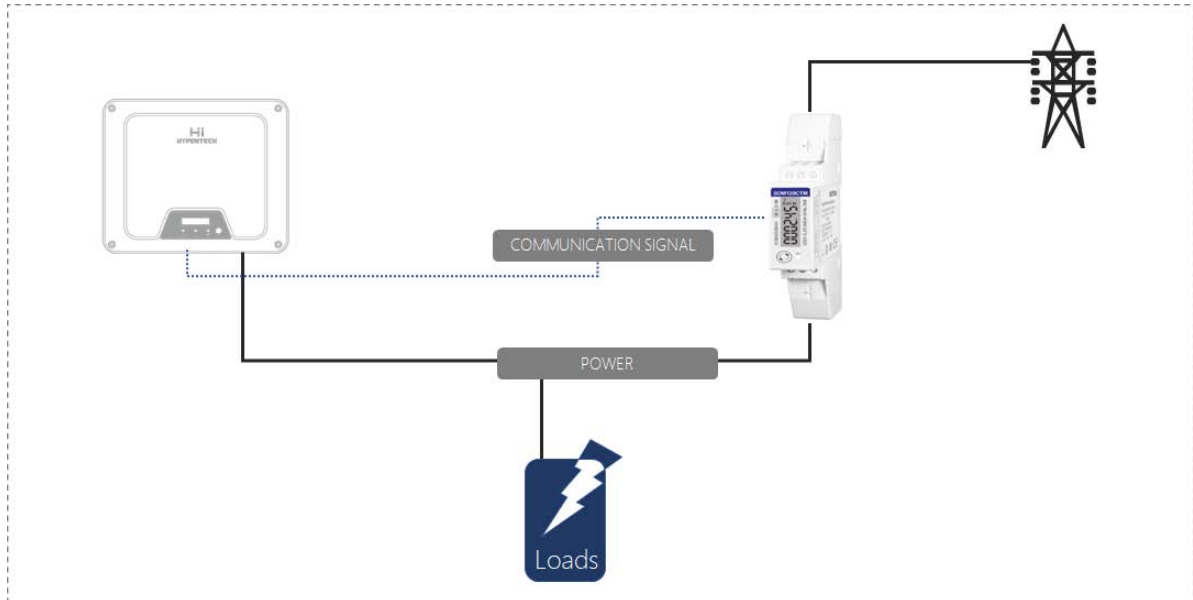

For installing and configuration of the smart meter, please check user manual [Smart Meter User Manual](#) . The manual is also available on [Download Section](#) of Hypontech Website.

Demand Responsive Mode (DRMs)



NOTICE

- **ONLY** applicable to Australian/New Zealand Standard: AS/NZS4777.2:2015.
- DRM0 is available.

Users can close the S9 on DREDBOX to activate DRED function and Operate the Disconnection Device by close S0. Other function of DRED is all disabled.

The inverter shall detect and initiate a response to all supported demand response commands.



WARNING

Moistures and Dust will damage the inverter

- Once connected please secure and tighten the screws on COM sealing plate.
- Warranty will be void if water or dust damages the inverter caused by poor installation of COM sealing plate.

COMMISSIONING



NOTICE

Qualified Personnel ONLY

Pre-Commissioning Safety Checklist

Before closing the inverter's DC Switch and switching on any voltage resources connected to the inverter, please check the conformity of your PV system to the following:

1. Grid Voltage

- Check at points of connection if the grid voltage complies with permitted range of the inverter.

2. Mounting Bracket

- Check if the mounting bracket is properly and securely installed to a solid surface.

3. Installation / Mounting

- Check if the inverter is properly mounted to the surface and securely attached to the mounting bracket.

4. DC Connections

- Check if DC connectors provided are assembled correctly and connected safely to the inverter.
- Check if DC connectors have the correct polarity (+ and -) and are allocated to the correct terminals (+ and -, MPPT1 and MPPT2, etc.).
- Check if the peak value of PV open-circuit voltage complies within the inverter's permitted range.

5. AC Connections

- Check if wires (L, N & PE) are safely assembled inside the AC connector is assembled correctly.
- Check if the AC connector is properly assembled, and swivel nuts are securely tightened.
- Check if the AC connector is firmly plugged into AC terminal.

6. Electrical Wires

- Check if all wires are reliably connected.
- Check if all established connections are working and effective, while insulation of wires are undamaged.

7. Groundings

- Check all groundings using a megger or a multimeter.
- Check if all exposed metal parts of the inverter are properly grounded.

8. Grounding Resistance

- Check if the grounding resistance of PV strings $>200\text{k}\Omega$ using a megger or a multimeter.

Commissioning Procedure

Commissioning the inverter that is equipped with a communication device

When the inverter is connected with a communication device (e.g. Wi-Fi Stick, GPRS Stick, Ethernet Stick, HiManager), the device is the unit for configuration of your entire PV system/plant.

The inverter does not require initial configuration to operate once installed and commissioned.

All inverters are compatible with HiPortal monitoring platform. Connection to HiPortal is highly recommended for [troubleshooting](#) purposes.

Commands of configuration are transferred to connected inverter units in the system, which then overwrites the settings of inverter. Malfunctions caused by unauthorized alterations of inverter settings will void guarantee and warranty terms.

Detailed instruction can be found in User Manual [HIportal USER MANUAL](#)

Procedure

1. Commission the inverter
2. Establish a connection to HiPortal
 - o Wi-Fi Stick via WLAN
 - o GPRS Stick
3. [Log into HiPortal](#) : Login page is the default page accessed by entering www.hyponportal.com in the web browser.

Type in registered e-mail address and password to login.

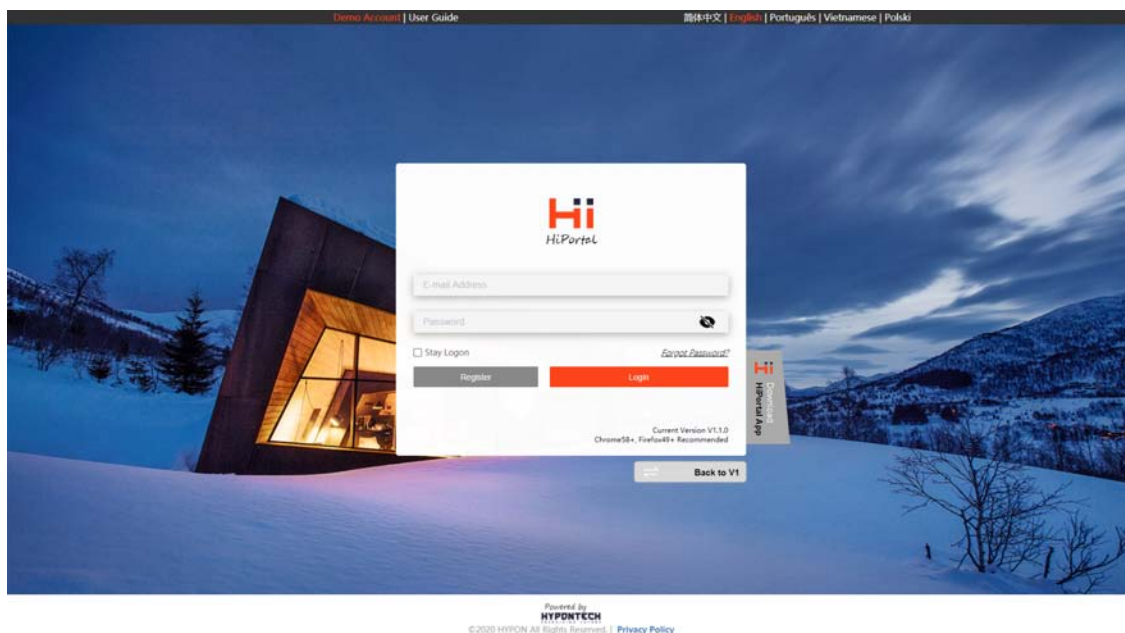

4. [Create your plant](#) : On this page, user may add a new plant.

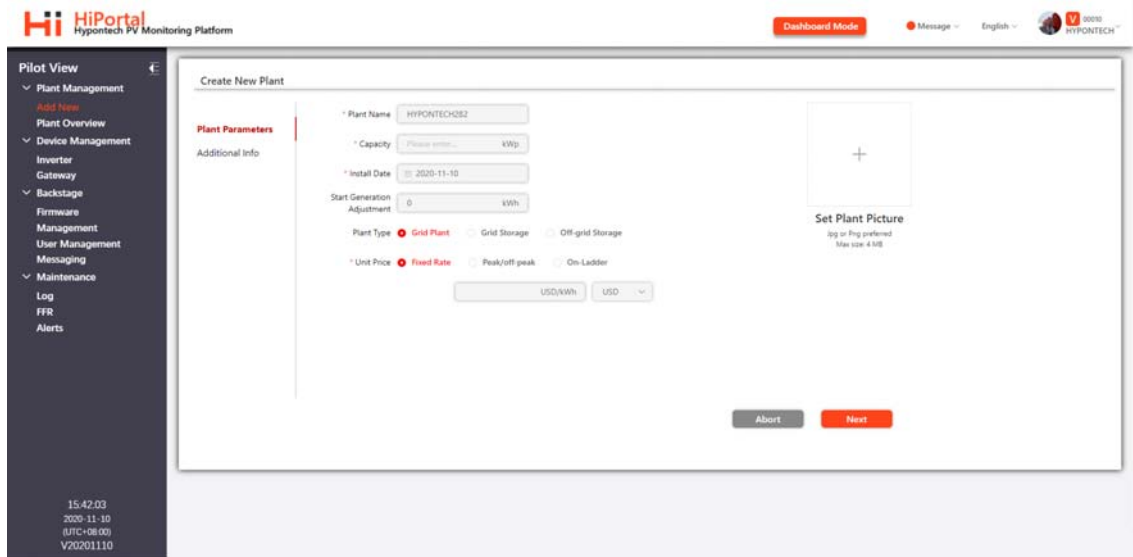

There are two pages of information which is needed to complete the operation.

- Plant Parameters

- Plant Name: [Mandatory] Give a name to this new plant. The system gives [Nickname + 3 digits random number] as a default plant name.
- Capacity: [Mandatory] Sum of all solar panels power in kWp.
- Install Date: [Mandatory] Date of today as default. Adjustable.
- Start Generation Adjustment: If the plant started generation before the user created the new plant, user can always put a power generated here.
- Plant Type:
 - Grid Plant: a grid-tied system
 - Grid Storage: a grid-tied system with energy storage
 - Off-grid Storage: a off-grid system with energy storage
- Unit Price: [Mandatory]
 - Type:
 - Fixed Rate: The FIT is paid in a fixed rate.
 - Peak/off-peak: The FIT is paid according to generating hour of the day.
 - On-Ladder: The FIT is paid according to the amount of the generation.
 - The unit FIT (Feed in tariff) price. Please confirm it is using the right currency.
- Set Plant Picture: User can put a photo of the plant. (a real plant shot appreciated)

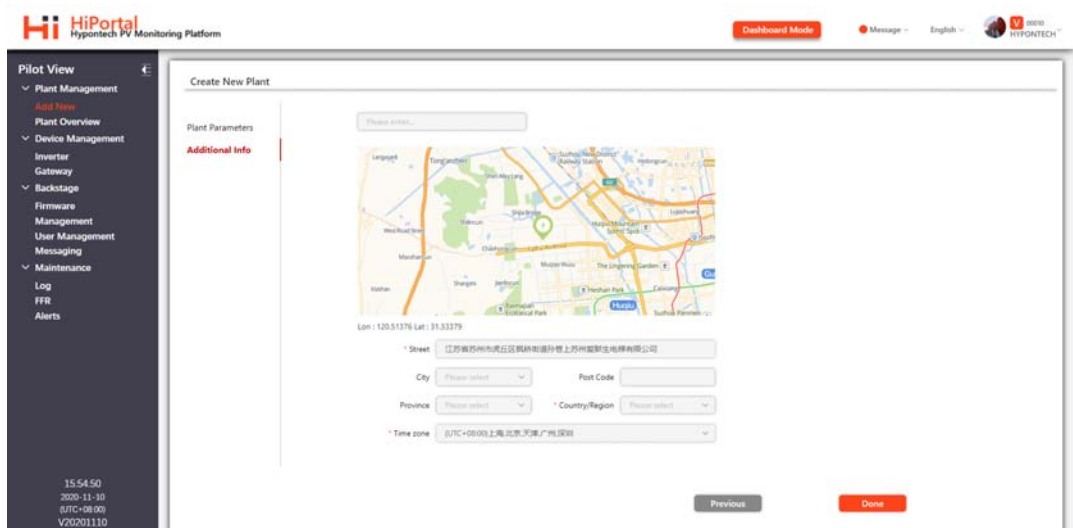

- o Additional Info:

To give geographic information of the plant. Country/Region and Time zone is mandatory.

5. Ensure country (and time zone) is configured correctly
6. Add your inverter to the plant
7. Make further settings as needed

Commissioning the Inverter



Requirements:

- AC Isolator must be in referenced ratings and correctly rated
- The inverter must be correctly mounted
- All cables must be correctly connected

Procedure:

1. Switch on the AC Isolator
2. Turn the DC Switch of the inverter to position I
3. If the red LED is glowing, an error has occurred and must be rectified (see [TROUBLESHOOTING](#))

Read the lights

 <p>POWER</p>	<ul style="list-style-type: none"> <input checked="" type="radio"/> ON Inverter Power ON and Feeding Power to Grid <input type="radio"/> Blink Inverter Power ON. Not Feeding Power to Grid <input type="radio"/> OFF Inverter Power OFF. DC Disconnected
 <p>FAULT</p>	<ul style="list-style-type: none"> <input checked="" type="radio"/> ON Inverter is Faulty <input type="radio"/> OFF No Fault
 <p>COM</p>	<ul style="list-style-type: none"> <input type="radio"/> Blink Communication Device Connected <input type="radio"/> OFF Communication Device Disconnected

Operating On the Inverter Interface



User can operate on the inverter by click on the button (C) on inverter interface as shown above.

LCD display (A) on the interface shows two lines of information. By short pressing the button, information will circulate in the sequence shown below:

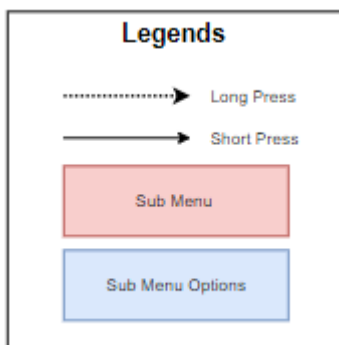
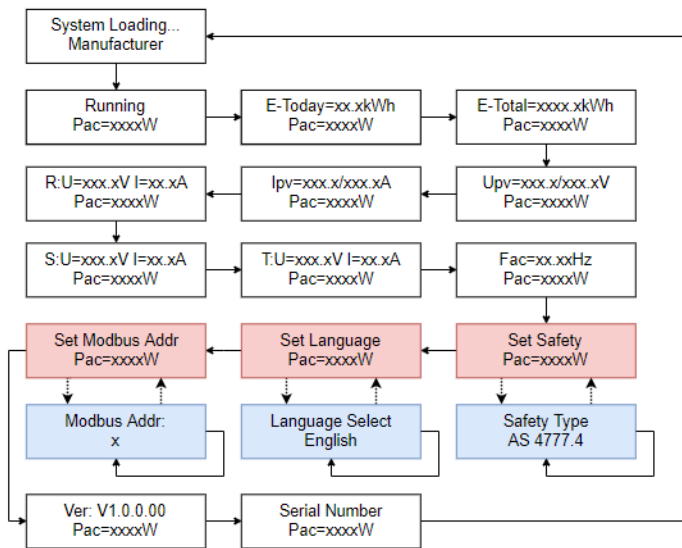

There are three sub menus which are Set Safety, Set Language, Set Modbus Addr, can be accessed by long pressing the button on correspondent screen. In the sub menu, short pressing the button can circulate items within the sub menu. Long pressing the button on certain screen will activate certain option and exit the sub menu.

Starting the Self-Test (for Italy only)



NOTICE

Configuration of Safety Standard overwrites the inverter's key parameters of grid connection and protections.

The Safety Standard of the inverter therefore must be set correctly.

A Safety Standard not applicable for your country and purposes may induce a disturbance in the PV system.

The self-test is a required function for inverters that feed into the grid in Italy by the standard of CEI 0-21. During the self-test, the inverter will consecutively check the reaction times for over-voltage, under-voltage, maximum frequency and minimum frequency.

The product described in this document is equipped with the self-test function when the grid standard of the inverter is opted to CEI.

After the self-test has been completed, the inverter automatically switches back to feed-in operation and resets the original disconnection conditions and connects to the grid. The test takes 3 minutes on average.

Inverters shipped for qualified Italian distributorship is set on default to the Safety Standard of CEI 0-21 and requires no further configuration.

Requirements:

The Safety Standard of the inverter must be set to CEI 0-21 internal.

Procedure:

- A. On Inverter user interface
- B. On HiPortal user interface (requires connection internet and the inverter is added in HiPortal)

DISCONNECTION AND RECONNECTION

Disconnecting

Before proceeding any operations on inverter, please disconnect the inverter from all voltage sources as described in Section [Pre-Commissioning Safety Checklist](#).

When disconnecting the inverter from voltage sources, always follow prescribed sequence in this document.

Having the inverter disconnected from voltage sources, the inverter needs to be fully discharged after disconnection.

Procedure:

1. Disconnect AC isolator and prevent it from unintentional reconnections.
2. If an external DC isolator is installed, disconnect external DC isolator from all voltage sources and prevent from unintentional reconnections.
3. On the inverter, set the DC Switch to position O.
4. Wait until the inverter's LEDs have gone out.
5. Apply current clamps to eliminate any electrical current in DC wires.
6. Disconnect and remove all DC connectors from the inverter.

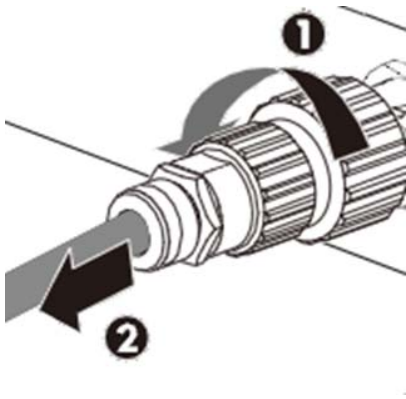

WARNING

DO NOT pull the cables to unplug DC connectors.

Instead, apply a solar connector tool (MC4 spanners / wrench) to the joint, and pull the DC connectors vertically downward.

7. Use a multimeter (or a suitable voltage measuring device) to the inverter's inputs to ensure there is 0 voltage present.



8. For the AC connector, loosen the swivel nut. Rotate the AC connector anticlockwise and remove it as a whole piece from the inverter.



DANGER

Danger to life due to high voltages

After disconnecting the inverter from both AC and DC voltage sources, please wait for 10 minutes for capacitors inside the inverter to fully discharge.

If any error occurs, DO NOT remove the cover of the inverter onsite.

Improper operations and attempts may induce electric shock.

Reconnecting

When reconnecting the inverter for electrical power supply, please follow the commissioning procedures and safety instructions as described in [CONNECTING THE PRODUCT](#) when applicable (e.g. DC Wires need to be reassembled).

Please run safety checks as described in Section [DC Connection](#) before closing the DC Switch and starting up again.

CLEANING AND MAINTENANCE

Cleaning the inverter

Cleaning the inverter regularly could ensure long-term performance of the inverter against dust, foliage and other dirt.



DANGER

HEAT SINK MIGHT INDUCE INJURY

When the inverter is operating, the heat sink might exceed 60°C

Disconnect all electrical connections.

Wait for **30 minutes** for the inverter to cool down completely.



WARNING

Using aggressive chemicals, cleaning solvents or strong detergents may damage the inverter and its components.

Using compressed air cleaning or a soft brush to clean the heat sink after decommissioning the inverter.

Refer to [Section Disconnecting](#) for decommissioning.

Maintenance Measures

Content	Maintenance Measures	How Often
System Cleaning	<ul style="list-style-type: none"> • Check if the heat sink is covered and dusted • Maintenance of DC Switch can be performed at night. Turn the switch to ON and OFF positions for 4~5 times. • Use a wet cloth to clean the display 	Annually / Semi-annually
System Status	<ul style="list-style-type: none"> • Inspect the enclosure for damage/deformation • Listen for abnormal noises during operation • Check if the parameters are normal during operation 	Semi-annually
Commissioning	<ul style="list-style-type: none"> • Check if the cables are loose • Check if the cable insulations are damaged, especially the parts in contact with metal surfaces 	Half a year after first commissioning Annually / Semi-annually
Grounding	<ul style="list-style-type: none"> • Check if the cables are securely grounded 	Half a year after first commissioning Annually / Semi-annually

RECYCLING AND DISPOSAL

To comply with European Directive 2012/19/EU on waste Electrical and Electronic Equipment and its implementation as national law, electrical equipment that has reached the end of its life must be collected separately and returned to an approved recycling facility. Any device that you no longer require must be returned to your dealer or you must find an approved collection and recycling facility in your area.

Ignoring this EU Directive may have severe effects on the environment and your health.



WARNING





This device **SHALL NOT** be disposed of in residential waste.



TROUBLESHOOTING

When the PV system does not operate normally, we recommend the following solutions for quick troubleshooting. If an error occurs, the Error code will be displayed on the inverter's screen or on the Hypontech's monitoring App/Web, the red LED will light up. The corresponding corrective measures are as follows:

Classifications of Fault Information

Fault Location	Fault Type	Error Message
 DC Side Fault	Failures caused by PV side wiring	F5 - PV voltage too high F6 - Surface insulation resistance error F7 - GFCI exceeds the permissible range
 AC Side Fault	Various faults caused by abnormal power grid or AC side wiring	F0 - 10min average voltage over the protection range F9 - No grid F10 - The grid voltage is out of range F11 - The grid frequency exceeds the range F19 - The voltage of N-PE is too high
 Inverter Fault	Fault code caused by inverter itself	F1 - MCU fault F2 - Current sensor fault F3 - GFCI sensor fault F4 - Relay fault F12 - Dc component out of range F13 - EEPROM fault F14 - Master and slave DSP communication failure
Others	It may be caused by external installation environment, PV side and inverter itself. Further Diagnoses needed.	F8 - Temperature is out of range F15 - BUS voltage is too high F16 - BUS voltage is too low F17 - DRM S9 fault F18 - DRM S0 fault

The Fault Of DC Side

Error Code	F5 - PV voltage too high
Fault Analysis	<p>When PV voltage of any string is greater than 580V (single phase) or 1020V (three phase), it is judged as PV voltage too high. The fault state will recovery when PV voltage reduce to below 570V (single phase) or 995V (three phase).</p> <p>Ensure the parameters of the input voltage meets the recommended range of the inverter.</p> <p>Low temperature may significantly affect the open-circuit voltage of the PV module. It should be fully considered.</p> <p>Measure the Voc (open circuit voltage of PV strings) to be sure.</p>
Verification and Measurement	
Error Code	F6 - Insulation resistance error
Fault Analysis	<p>PV+ and PV- are measured for insulation impedance to the ground during the power-on start-up process. When the measured insulation impedance is less than 200kΩ, it is judged as insulation resistance error.</p> <p>Whether the fault is continuous?</p> <p>Whether the failure occurs frequently</p> <p>Is it only occurred in rainy weather or when there is more often in the morning?</p> <p>Is there water ingress in the PV cable? Broken skin?</p> <p>When there are more than one string, unplug the PV string one by one and switch on the DC switch, then observe whether the alarm is eliminated or only happen to one string of cable.</p>
Verification and Measurement	<p>Measure the Voltage between PV+ and the ground</p> <p>Measure the Voltage between PV- and the ground</p> <p>If the resistance of PV+ to the ground > 200KΩ?</p> <p>If the resistance of PV- to the ground > 200KΩ?</p>
Error Code	F7 - GFCI Fault
Fault Analysis	<p>The system leakage current exceeds the protection threshold:</p> <p>Whether it only happens in rainy days or humid environment?</p> <p>Whether the inverter is properly grounded?</p> <p>Whether the AC side and photovoltaic system grounded normally and reliably?</p> <p>When multiple strings are connected, plug in and out one by one, and confirm whether it is a problem only on one string.</p>
Verification and Measurement	<p>If the problem point cannot be located, the insulation impedance of AC and DC side shall be measured with a megger, which shall be generally greater than 200K Ω.</p>



NOTICE

If you have any questions, please contact Hypontech service department

The Fault Of AC Side

Error Code	F0 - 10 min average voltage of AC is over range
Fault Analysis	The AC voltage is unstable, and the 10 min average voltage of AC is over protection value
Verification and Measurement	Increase the voltage range via screen button which called ONE KEY FUNCTION Please contact Hypontech Service Department for instruction of ONE KEY FUNCTION

Error Code	F9 - No Grid
Fault Analysis	Inverter cannot detect grid voltage: Whether the grid is normal? Whether the AC switch trips? Whether the AC wires is connected properly? Whether the AC voltage displayed by the inverter is in normal range? Is the AC voltage displayed on HiPortal normal?
Verification and Measurement	Measurement of multi meter Vac=? Measure AC voltage at each contact point

Error Code	F10 - Grid voltage is out of range
Fault Analysis	The grid voltage is beyond the scope of safety regulations: Is the selection of grid connected safety standards correct? Whether the connection of AC wires is reliable? Whether the fault continues, or occurs in a certain period of time or with the increase of output power? What is the measured grid voltage? How much is the difference compared with the grid voltage displayed by the inverter? What is the local power grid environment like? Is the grid voltage always high? Are there some factories nearby?
Verification and Measurement	In the area of weak grid network (remote districts) or the area near the factory, the fluctuation of power grid is often large, which is easy to cause the protection of power grid voltage Measurement of multi meter Vac=? At the moment of switch tripping, voltage fault will be reported randomly. For three phase inverter, check the voltage of L1-L2, L1-L3, L2-L3 to make sure the line voltage is normal.

Error Code	F11 - The grid frequency is over the range
Fault Analysis	<p>The grid frequency is beyond the scope of safety regulations :</p> <ul style="list-style-type: none"> Is the selection of grid connected safety standards correct? Whether the connection of AC wires is reliable? Whether the fault is continuous or just occur in certain time of a day? Consider local power grid environment. Are there any factories nearby?
Verification and Measurement	<ul style="list-style-type: none"> In the area near the factory, the fluctuation of power grid is often large, which is easy to cause the protection of power grid frequency. At the moment of switch tripping, frequency fault will be reported randomly.
Error Code	F19 - The voltage of N phase to PE is over the range (Three phase inverter)
Fault Analysis	<p>The voltage of N phase to PE is over 50V</p> <ul style="list-style-type: none"> Whether the grounding wire is connected correctly? Whether the connection of AC wires is right? Whether the voltage of phase to phase and phase to ground is in normal range?
Verification and Measurement	Reconnect the grounding wire and make sure the grounding wire being connected to inverter properly.

The Fault Of Inverter

Error Code	Failure Analysis	Verification and Measurement
F1 - MCU fault	Self-check error of MCU during inverter start-up	
F2 - Current sensor fault	Self-check error of current sensor during startup	
F3 - GFCI sensor fault	Self-check error of current leakage sensor during startup	
F4 - Relay fault	Self-check error of grid-connected relay during startup	Disconnect the AC and DC side power supply until the screen is completely extinguished, and then power on again to observe whether the fault is eliminated;
F12 - DC component of the electricity exceeds the permissible range	The DC component of AC current exceeds 1A in steady-state process and 4A in dynamic process	If the inverter fails to eliminate the fault, please contact Hypontech service department;
F13 - EEPROM fault	MCU failed to read and write EEPROM	
F14 - Internal communications fault	Communication fault between Master DSP and Slave DSP	

Other Fault Types

Error Code	Failure Analysis	Verification and Measurement
F8 - Inverter temperature too high (out of range)	<p>The temperature of radiator and internal environment is higher than 85 °C (or the temperature is lower than - 30 °C)</p> <p>Is the machine surface temperature abnormally high?</p> <p>Is the installation position well ventilated? Whether there are obstacles (whether the cooling fan is damaged, ≥ 15kW model)</p> <p>Is the equipment covered by canopy or direct sunlight?</p>	<p>Take photos of the installation location and send them to Hypontech Service Department to further analyze the problem.</p>
F15 - BUS Voltage is too high	<p>Bus voltage above protection threshold</p> <p>Whether the fault is continuous?</p> <p>Whether the PV voltage is normal?</p>	<p>$V_{pv}=?$</p> <p>If the power grid has large fluctuation or occasionally occurs at the moment of start-up, try to disconnect the AC and DC side power supply, restart the inverter, and observe whether the fault is eliminated. If the inverter fails to eliminate the fault, please contact Hypontech Service Department.</p>
F16 - BUS Voltage is too low	<p>BUS Voltage below protection threshold:</p> <p>Whether the fault is continuous?</p> <p>Whether the PV voltage is normal?</p>	
F17 - DRM S9 Fault	<p>DRM Switch 9 Fault</p> <p>Is the external wiring correct</p>	
F18 - DRM S0 Fault	<p>DRM Switch 0 Fault</p> <p>Is the external wiring correct</p>	

Type

Display Sample

On App



On Display



On HiPortal, event list of a plant, you can query the fault information of all equipment in the PV plant. If you long press (on app) or hover over (on webportal) the fault information, the fault explanation and corresponding counter measures will pop up and help you to deal with the fault;

You can contact Hypontech if you do not know how to handle it. It is highly recommended to have necessary materials prepared in advance which will accelerate the process.

Materials are listed in the last part of this document.

The red indicator will light up as left picture shows when the inverter has the fault, the screen also can display the operation parameter of the current state.

You can contact Hypontech if you do not know how to handle it. It is highly recommended to have necessary materials prepared in advance which will accelerate the process.

Materials are listed in the last part of this document.

Problems caused by monitoring

No.	Problem	Corrective Measures
1	Your Phone or laptop cannot search for "EAP" AP (Access Point)	<p>Confirm that the inverter is powered on and the WiFi module is correctly installed</p> <p>Make sure that the mobile phone or laptop is not too far away from the inverter (WiFi stick), it is recommended to be within 10 meters</p> <p>Restart the inverter (disconnect the DC switch, turn on the power after the LED goes out)</p> <p>Refresh mobile phone or computer wireless hotspot</p>
2	Cannot connect to the "EAPxxxxx"	<p>Confirm whether the input password is 12345678</p> <p>Confirm whether the laptop or mobile phone is too far away from the inverter (WiFi stick)</p> <p>Restart the inverter (disconnect the DC switch, turn on the power after the LED goes out)</p>
3	Cannot log in to the configuration page (web page)	<p>Confirm whether the entered address is: 10.10.10.1</p> <p>It is recommended to use more commonly used browsers such as IE and Chrome</p>
4	Can't find your home wireless network hotspot (SSID) on the search page	<p>Make sure that the router is close enough to the inverter and the signal is good enough</p> <p>Use a mobile phone or computer to first try to search whether the wireless signal is normal and visible</p> <p>If you use android phone, shut off the 4G or 5G signal is recommended</p>
5	After the configuration is completed, the inverter is still offline, and the inverter cannot be seen in the APP or web site	<p>Make sure to add the inverter to the solar plant first. The steps for adding are :create a solar plant → select device → add device → enter the gate way SN (app can directly scan the SN code), and then the binding is completed</p> <p>After the correct binding, if the network is guaranteed to be normal, there will be a certain delay in data upload, refresh the page several times, and wait about 5 minutes.</p>
6	Scan QR code unsuccessful	<p>Pay attention to distinguish the APP download code and the SN code of the monitoring module</p> <p>The Android system needs to allow location permission before scanning the Qr code</p>

Earth Fault Alarm

The inverter complies with IEC 62109-2 clause 13.9 for earth fault alarm monitoring.

When an earth fault presents in the PV system, the inverter displays Fault 6 on the LCD with red light glowing.

Event Notification

When indication of error events is required, they can be sent to the user as notification emails by toggling Event Notification on HiPortal.

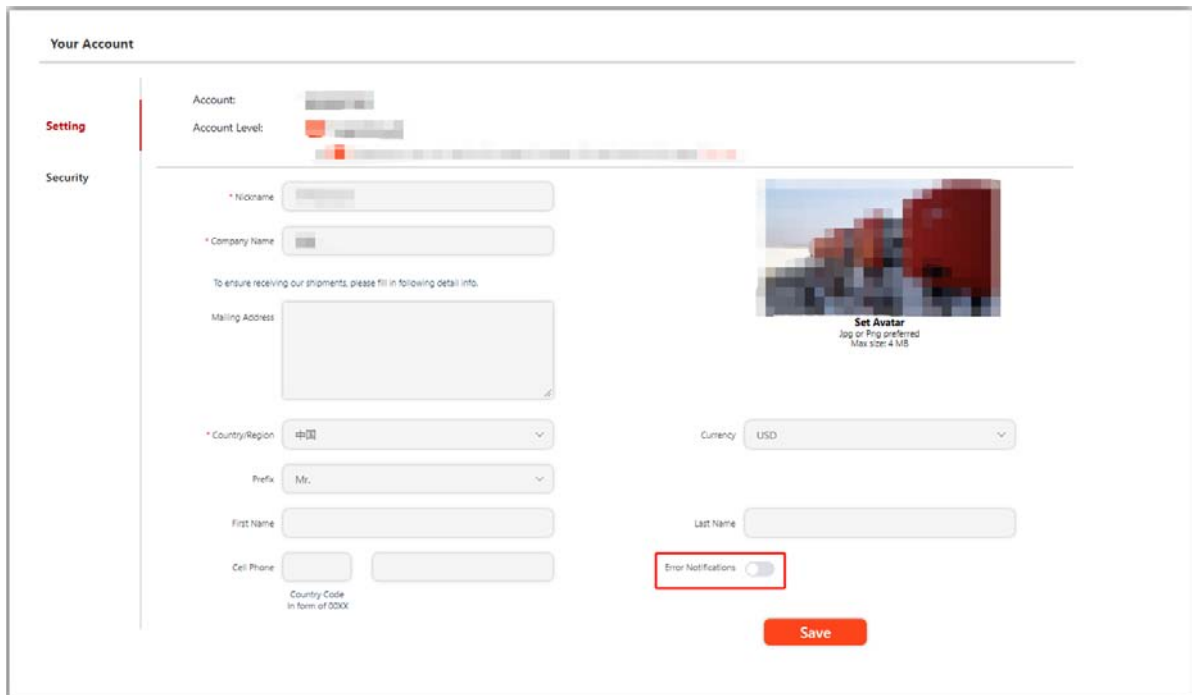

The screenshot shows the 'Your Account' settings page. On the left, there is a sidebar with 'Setting' and 'Security' options. The main content area contains various input fields and a toggle switch. The 'Error Notifications' toggle switch is highlighted with a red box. Below it is a red 'Save' button. The page also includes a 'Set Avatar' button and a note about avatar requirements: 'Jpg or Png preferred, Max size: 4 MB'.



NOTICE

This function is assigned to all accounts on HiPortal and is set disabled by default.

Requirement:

The inverter must be commissioned and connected to the monitoring platform on HiPortal.

Please refer to #HiPortal User Manual on how to setup your inverter communication function.

Only users who have ownership of PV plants on HiPortal (e.g. creator of the plant) has the authority to toggle this function and receive event messages for a plant.

Procedure:

1. Log in to HiPortal on web browser
2. Go to Account Settings
3. Toggle Error Notifications
4. Select Save

Error Notifications are sent to the user's e-mail account.



NOTICE

This function can be toggled off any time.

PRODUCT PARAMETERS

MODEL	HPT-15K	HPT-17K	HPT-20K	HPT-25K
INPUT / DC				
Max. PV Power / Wp	22500	25500	30000	30000
Max. Input Voltage / V	1000			
MPP Voltage Range / V	150 - 900			
Min. DC Voltage / Start Up Voltage / V	150/180			
Full load MPP voltage range / V	330 - 900	380 - 900	430 - 900	500 - 900
Nominal DC-Input Voltage / V	620			
Max. Input Current / A	26/26			
Max. DC Short Circuit Current / A	40/40			
No. of Independent MPPT Inputs	2			
No. of PV Strings per MPPT	2			
OUTPUT / AC				
Rated Power / W	15000	17000	20000	25000
Max. Apparent AC Power / VA	16500	19000	22000	25000
Rated Grid Voltage / Vac	380/400 3 / 3-N-PE			
Rated Power Frequency / Hz	50/60			
Max. Output Current / A	24	27.6	31.9	36.3
Power Factor	0.8ind to 0.8cap			
THDi at Rated Power	<3%			
EFFICIENCY				
Max. Efficiency	98.6%			
Euro Efficiency	98.2%			
PROTECTION				
Anti-Islanding Protection	Integrated			
Input Reverse Polarity Protection	Integrated			
Insulation Resistor Detection	Integrated			
Residual Current Monitoring Unit	Integrated			
Output Over Current Protection	Integrated			
Output Short Circuit Protection	Integrated			
Output Over Voltage Protection	II (DC), III (AC)			
Surge Protection	DC: Optional / AC: Type II			
GENERAL DATA				
Dimensions (W*H*D) / mm	425*351*200			
Weight / kg	20			
Noise Emission (typical) / dB (A)	<45			
User Interface	LCD&LED or LED			
DC Connection Type	Mc4 (D4, SUNCLIX, H4 Optional)			
AC Connection Type	Plug-in Connector			
Communication	RS485/WIFI/GPRS (Optional)			
Cooling Method	Smart Fan cooling			
Operating Ambient Temperature / °C	-25°C - +60°C			
Relative Humidity	0% - 100%			
Max. Operating Altitude / m	2000 (>2000 Derating)			
Degree of Protection (IEC 60529)	IP65			
Climatic Category (IEC 60721-3-4)	4K4H			
Isolation Method	Transformerless			
Power Loss On Night Mode / W	<1			

This document, as well as any data and information included herein, may be updated without announcement. All rights of interpretation are reserved by Hypontech.

20201201EN

HYPONTECH
ENERGIZING FUTURE

www.hypontech.com

CHINA HEADQUARTER Address: No. 1508 Xiangjiang Rd, SND, Suzhou 215129
Email: info@hypontech.com / Service Email: service@hypontech.com / Contact No.:+ 86 512 8071 2199



NOTICE

Product data updates continuously. Any data change will not be informed exclusively. Hypontech Reserves the rights of final interpretation of product technical data and copyrights.

Inverter power quality response modes

Power quality response modes	Default operation per AS/NZS 4777.2:2015
Volt-watt response mode	Default: Disabled
Volt-var response mode	Default: Disabled
Fixed power factor mode	Default: Disabled
Reactive power mode	Default: Disabled
Characteristic power factor curve for $\cos \phi$ (P)	Default: Disabled



NOTICE

The power quality modes can be enabled or disabled via our monitoring APP or Web. Please refer to the "Safety Parameter Setting User Manual" on our website at [Download Section](#), or contact our service for more information. Please access the monitoring platform on www.hyponportal.com.

Certification

Grid Standards

EN50549-1, AS/NZS4777.2, G98, G99, NBR16149, NB/T32004, IEC61727

Safety Standards

IEC/EN62109-1/-2, NB/T32004

Electromagnetic Compatibility (EMC)

EN61000-6-1, EN61000-6-2, EN61000-6-3, EN61000-6-4, NB/T 32004



NOTICE

Certification information could be updated. The recent information can be found in Hypontech website www.hypontech.com or consult a sales engineer via sales@hypontech.com.

CONTACT

CHINA APAC GENERAL

Suzhou Hypontech Co., Ltd.

No.1508 Xiangjiang Road, SND, Suzhou 215129

+86 512 80712199

service@hypontech.com

HYPONTECH Online Support

www.hypontech.com/service

BRAZIL

HYPONTECH Brazil Service
Office

Rua Rui de Paiva Lima, 190 "C Distrito Industrial Araguari "C
MG, 38446-398

+34 4105-0011

+34 4105-1100

service@hypontech.com

HYPONTECH Online Support

www.hypontech.com/service

EUROPE / NETHERLANDS

HYPONTECH Europe
Service Office

Waalhaven ZZ 19, 3089 JH, Rotterdam

Netherlands

service@hypontech.com

HYPONTECH Online Support

www.hypontech.com/service

AUSTRALIA

HYPONTECH Australia Pty
Ltd.

Unit 604/7 Jenkins Rd

Carlingford, NSW 2118 59, Carlingford, NSW 2118

+61 (0)2 8054 0377

service.au@hypontech.com

Service Hub

59 Tacoma Circuit Canning Vale, WA 6155

HYPONTECH Online Support

www.hypontech.com/service

